

# B16-3 Offroad

Volvo FM (SLP) 2022

Doc: DB000133



B16-3 DB000133 A

**TRUX**<sup>®</sup>  
*Always in the frontline*



2120

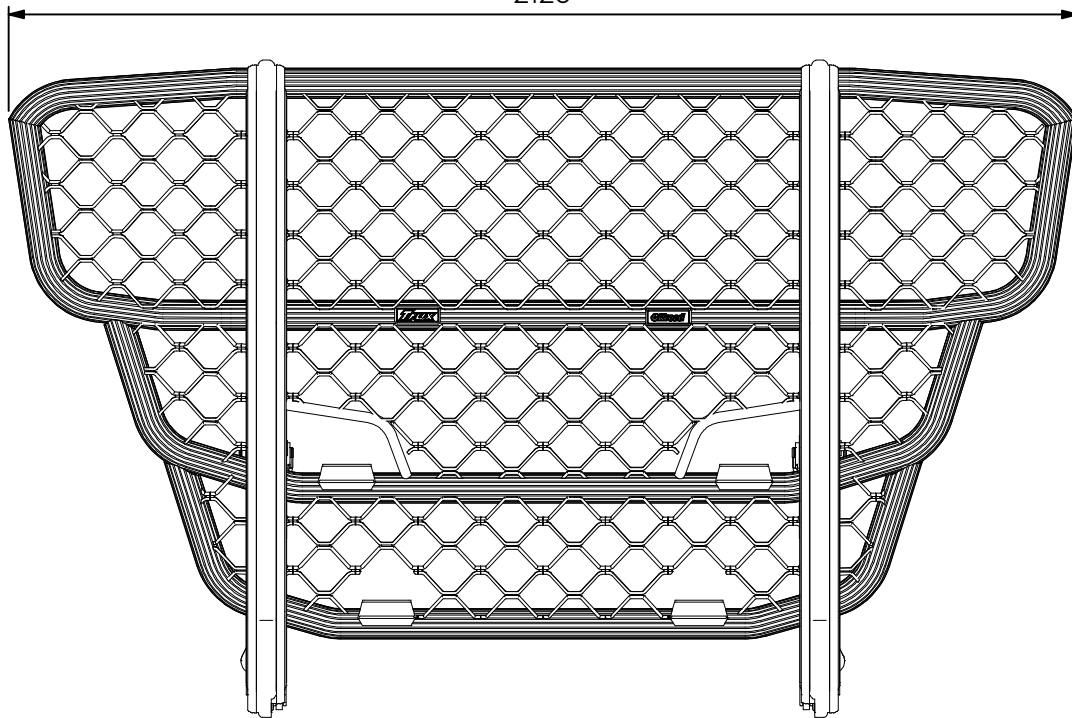

221

1304

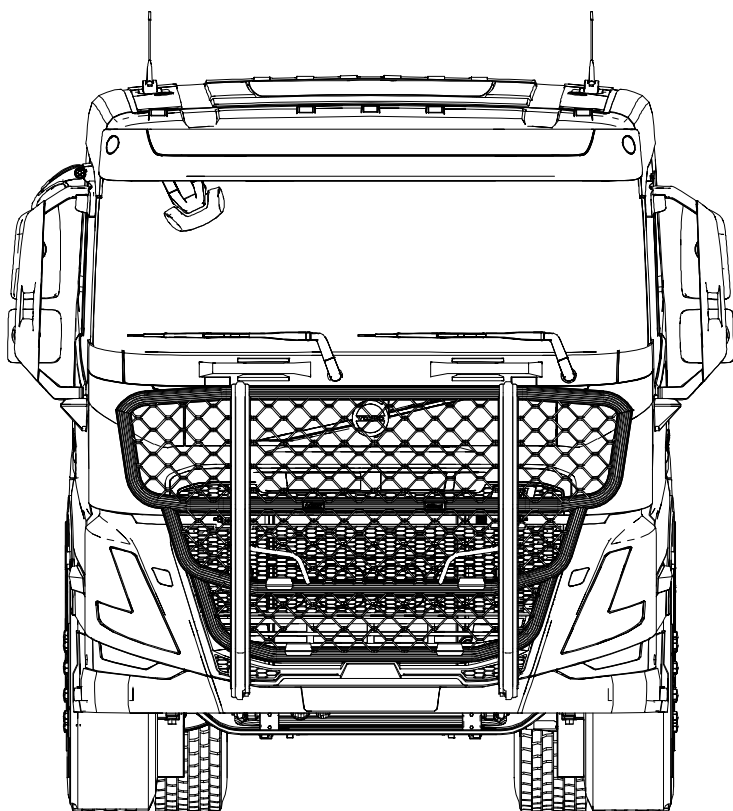
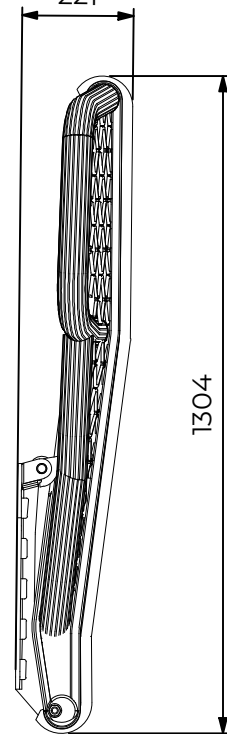

B16-3 DB000133 A

**TRUX**<sup>®</sup>  
*Always in the frontline*



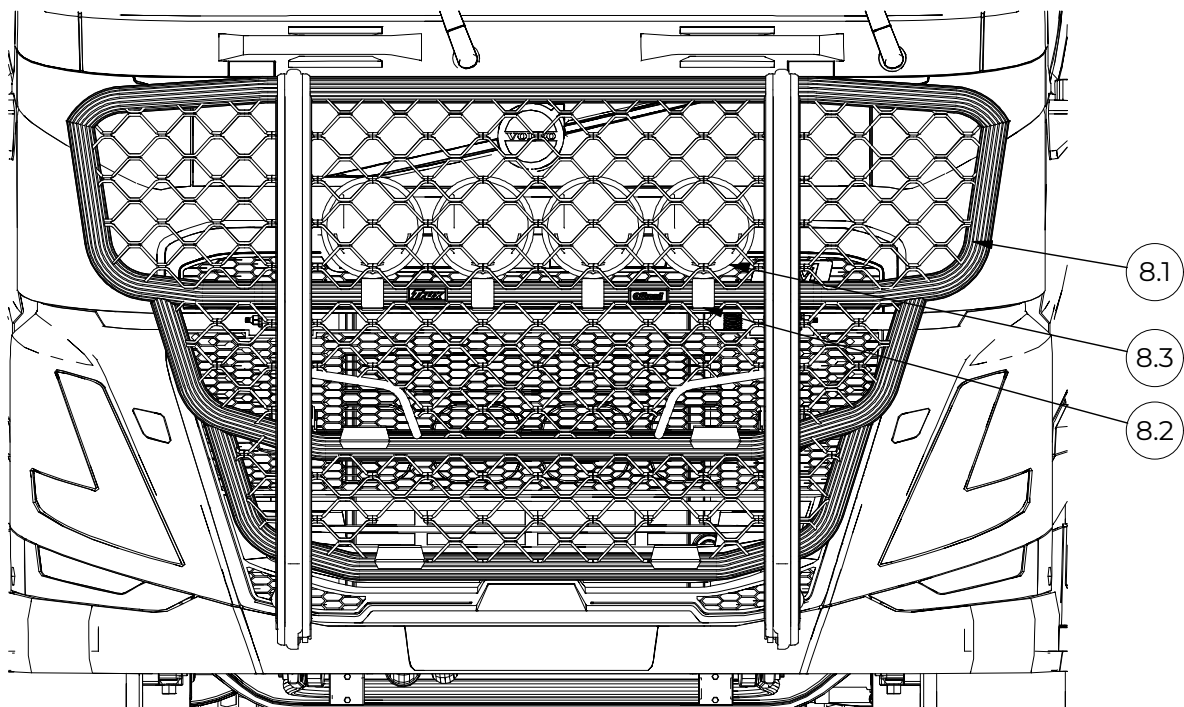

Pos.	Art.nr	Benämning	Vikt	Antal
8.1	B16-351	Offroad	36,5 kg	1
8.2	15903	AF Klämfäste Ø60x50 mm	0,3 kg	4
8.3		Extraljus	0,5 kg	4

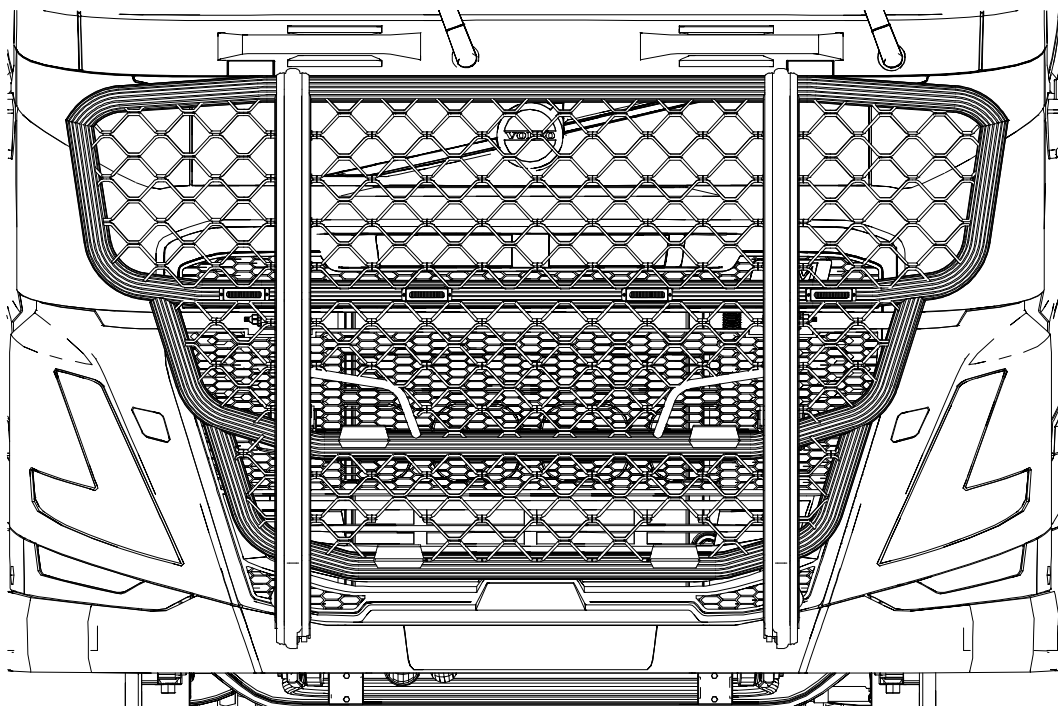

Pos.	Art.nr	Benämning	Vikt	Antal
8.1	B16-351	Offroad	36,5 kg	1
8.4		Blixtljus LED	0,2 kg	4

**TRUX**<sup>®</sup>  
*Always in the frontline*





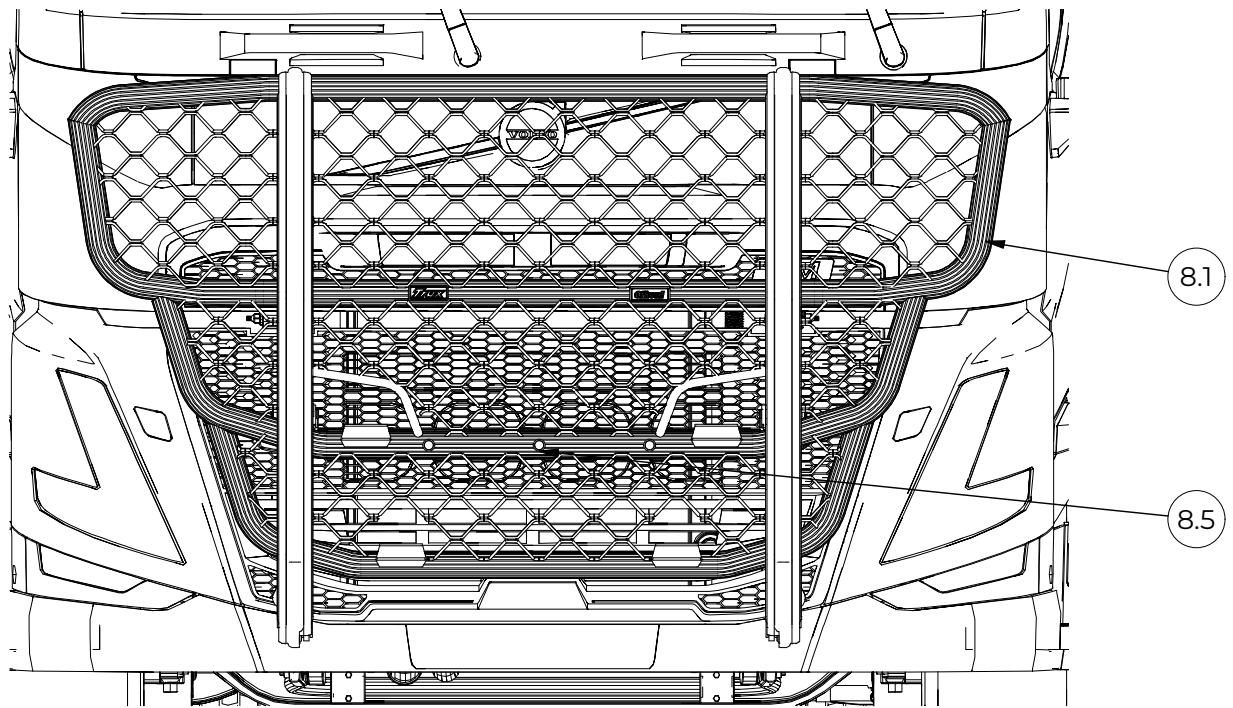

Pos.	Art.nr	Benämning	Vikt	Antal
8.1	B16-351	Offroad	36,5 kg	1
8.5	97193	Monterad LED med 3 lampor Vit	0,4 kg	1

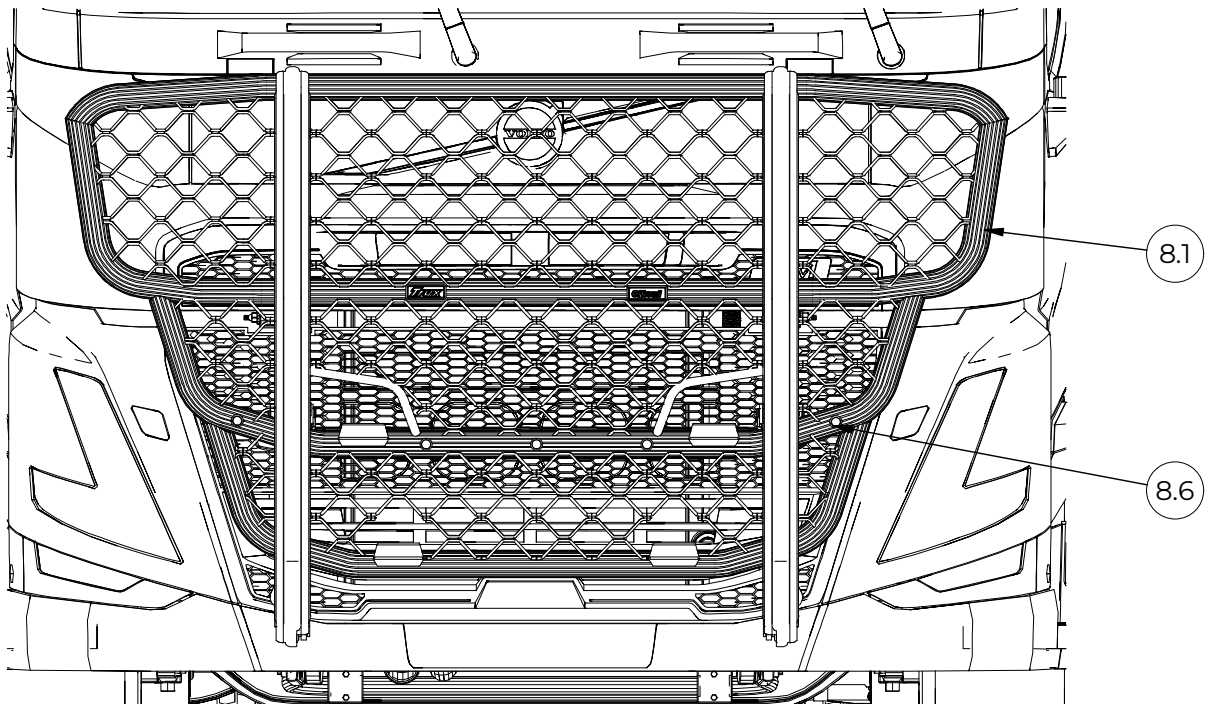

Pos.	Art.nr	Benämning	Vikt	Antal
8.1	B16-351	Offroad	36,5 kg	1
8.6	97170	Monterad LED med 5 lampor Vit	0,6 kg	1

**TRUX**<sup>®</sup>  
*Always in the frontline*