

VOLVO FH



Trux[®]

Always in the frontline

Trux Top-Bar G16-6
Trux Offroad B16-2
Trux U-Bar L16-2
Trux Sideliner S-1



VOLVO FH Globetrotter XL (XHSL)

Trux Light-Bar H16-6
Trux X-Light K16-3



Trux X-Bar H16-4
Trux U-Bar L16-2



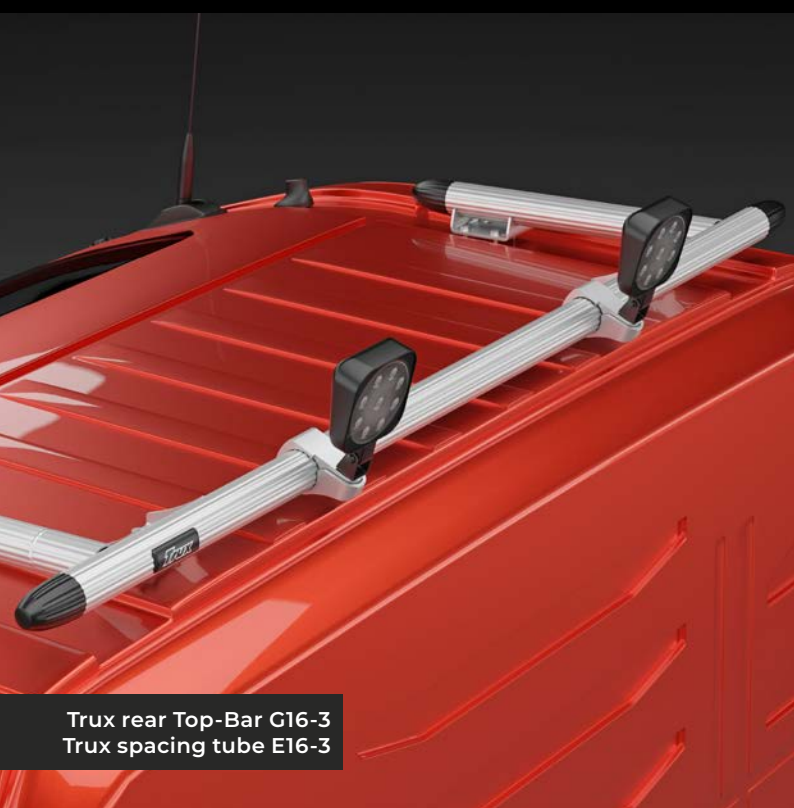

Trux rear Top-Bar G16-3
Trux spacing tube E16-3



Trux rear Light-Bar P16-2

Trux Top-Bar G16-4
Trux Highway A16-2
Trux Sideliner S-1



VOLVO FH16 Globetrotter (HSLP)

Trux X-Light K16-3



Trux X-Bar H16-4
Trux U-Bar L16-2



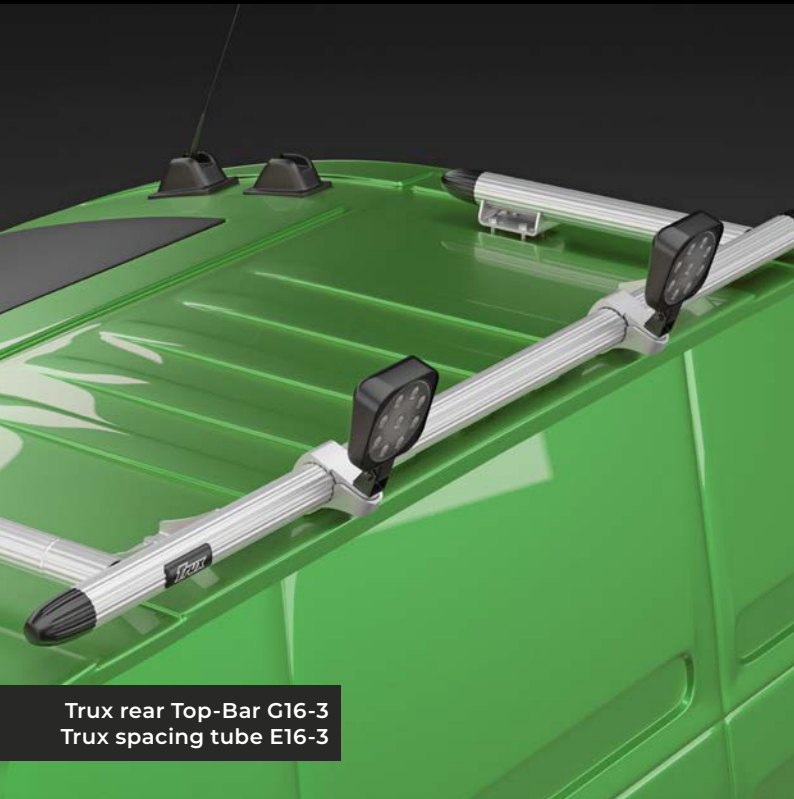

Trux rear Top-Bar G16-3
Trux spacing tube E16-3

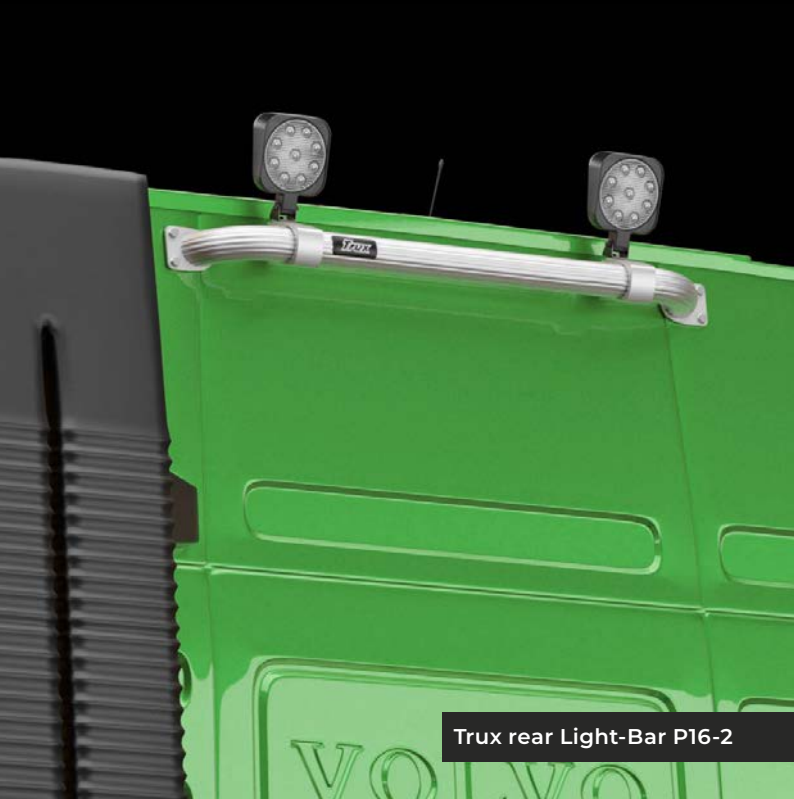

Trux rear Light-Bar P16-2

Trux Top-Bar G16-7
Trux Offroad B16-4



VOLVO FH Low (SLP) with BUMP-HD

Trux X-Bar H16-4

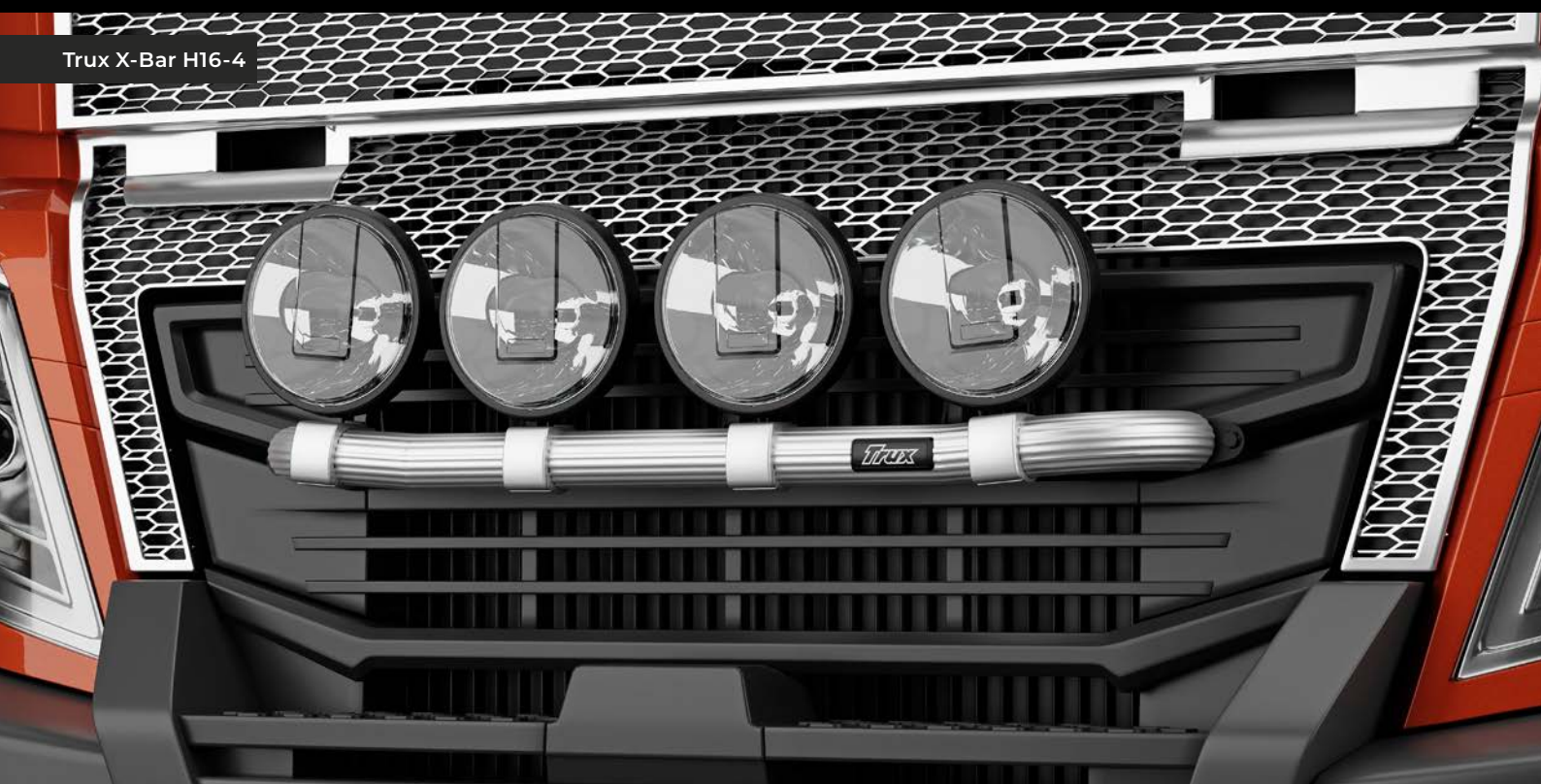



Trux rear Top-Bar G16-1
Trux spacing tube E16-2



Trux rear Light-Bar P16-2

PRODUCT RANGE

A16-2 Highway
 Estimated fitting time: 1 hour
 Overhang of vehicle: 255 mm
 Weight: 52 kg



B16-2 Offroad
 Estimated fitting time: 1 hour
 Overhang of vehicle: 245 mm
 Weight: 43 kg



B16-4 Offroad
Fits: Truck with construction bumper
 Estimated fitting time: 1 hour
 Overhang of vehicle: 120 mm
 Weight: 40 kg



B16-4T Offroad
Fits: Truck with construction bumper and tow bar PCA70062
 Estimated fitting time: 1 hour
 Overhang of vehicle: 150 mm
 Weight: 40 kg



G16-2 Top-Bar
Fits: Sleep cab (SLP)
 Estimated fitting time: 1 hour
 Weight: 3,5 kg



G16-4 Top-Bar
Fits: Glob (HSLP) Glob XL (XHSL)
 Estimated fitting time: 1 hour
 Weight: 4 kg



G16-6 Top-Bar
Fits: Sleep cab (SLP) Glob (HSLP) Glob XL (XHSL)
 Estimated fitting time: 1 hour
 Weight: 6,5 kg



G16-7 Top-Bar
Fits: Sleep cab (SLP)
 Estimated fitting time: 1 hour
 Weight: 4,5 kg



G16-1 Rear Top-Bar
Fits: Sleep cab (SLP)
 Estimated fitting time: 0,5 hour
 Weight: 3 kg



G16-3 Rear Top-Bar
Fits: Glob (HSLP) Glob XL (XHSL)
 Estimated fitting time: 0,5 hour
 Weight: 3,5 kg



H16-4 X-Bar
 Estimated fitting time: 1 hour
 Overhang of vehicle: 160 mm
 Weight: 3,5 kg



H16-6 Light-Bar
 Estimated fitting time: 1 hour
 Overhang of vehicle: 125 mm
 Weight: 4 kg



K16-3 X-Light
Fits: Truck without collision warning
 Estimated fitting time: 0,5 hour
 Overhang of vehicle: 190 mm
 Weight: 9,5 kg



L16-2 U-Bar
 Estimated fitting time: 0,5 hour
 Weight: 6 kg



P16-2 Rear Light-Bar
 Estimated fitting time: 0,5 hour
 Weight: 2 kg



S-1 Sideliner
0-2 500 mm
S-2 2 501-5 000 mm



- Roof mounting
 Includes Top-Bar, rear Top-Bar, spacing tube and catwalk



98186 Cable with Volvo contact
Fits: Top-Bar G16-2 Top-Bar G16-4 Top-Bar G16-6
 For 2 warning lights (needs preparation on truck). Cable to the left.



98187 Cable with Volvo contact
Fits: Top-Bar G16-2 Top-Bar G16-4 Top-Bar G16-6
 For 2 warning lights (needs preparation on truck). Cable to the right.



98188 Cable with Volvo contact
Fits: Top-Bar G16-2 Top-Bar G16-4 Top-Bar G16-6
 For 4 spotlights (needs preparation (SPOT.P.R) on truck). Cable to the left.



FITTING TIME IS EXCLUDING WIRING. THE WEIGHTS INDICATED ARE FOR THE BAR ONLY – EXCLUDES ACCESSORIES